

123.5
Refer to the chart

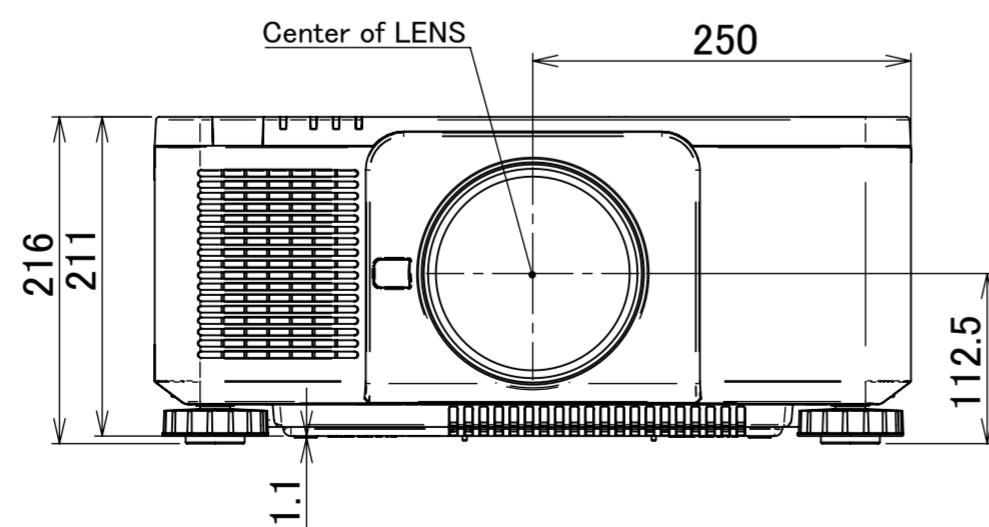
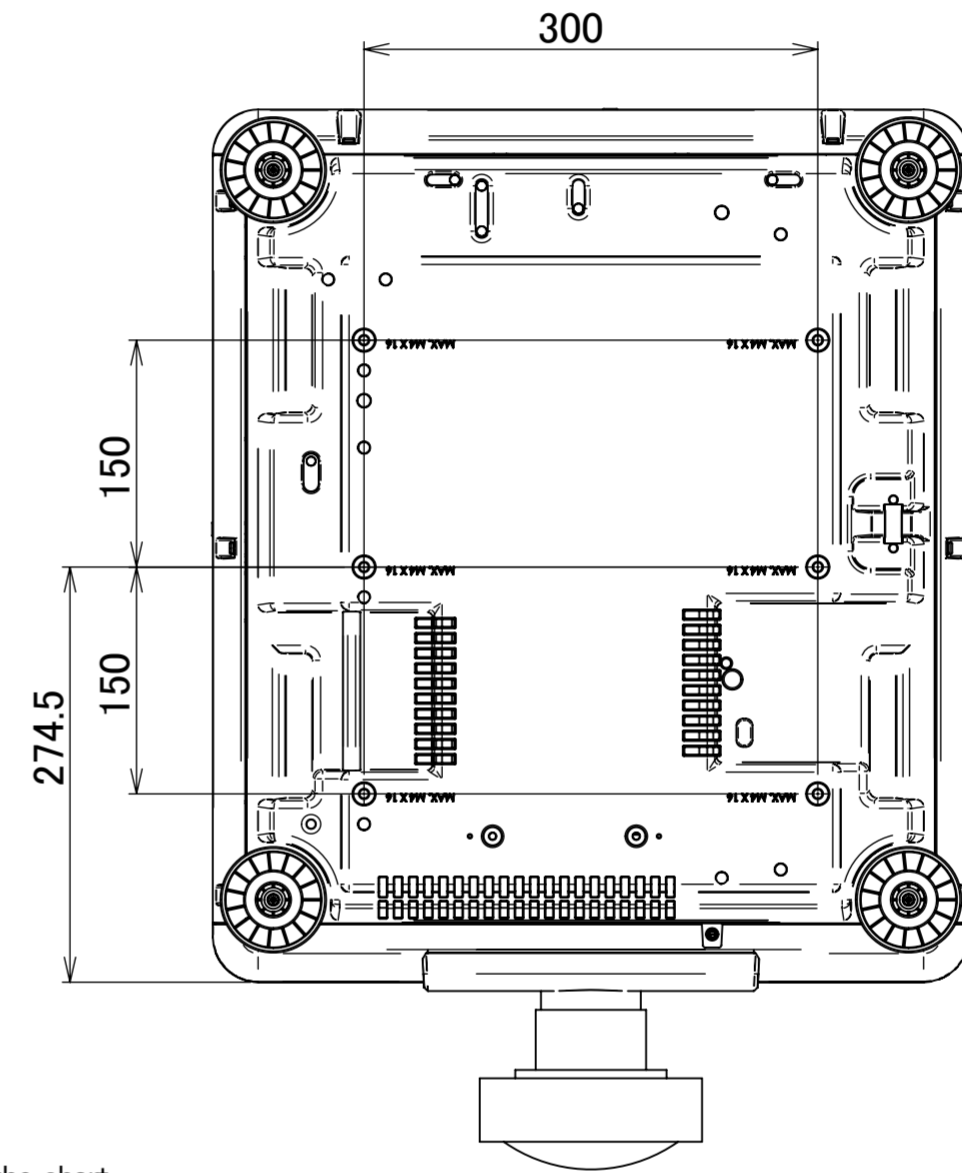

X141Q Series with Option Lens

	Protruding value (mm)
XP-58ZL	135.2
XP-59ZL	123.5
XP-60ZL	131.9
XP-61ZL	132.7
XP-62ZL	159.9

REV	DESCRIPTION
1	2024.12.18
1.1	2025.10.24
Sharp Corporation	